



ORTHOPEDIC IMPLANTS CATALOGUE

www.phoenixsurgicalsolution.com

For over ©1990-2025 years **PHOENIX SURGICAL** has been devoted to providing its customers with the highest quality Surgical, Dental, Beauty and Podiatry Instruments.

PHOENIX SURGICAL is committed to provide you with the highest quality instruments. We are the original equipment manufacturer (OEM) for all above mention instruments.

Our production depth covers thousands of instruments ranging from the typical instruments use in clinic to sophisticated instruments required during surgeries. We deem, however, pertinent to submit further that the range and scope of our production activities is not limited to our production literature. We can produce instruments even if not depicted in our online catalogues. We receive samples, photos or references from the world-renowned companies catalogues.

QUALITY/ INNOVATION

At **PHOENIX SURGICAL** the quality is set in motion through motivated specifications planning by trained technical persons. The computer added design and imaging provide visual instruments a set configuration. This simplifies each aspect of instruments manufacturing.

COMMITMENT:

Our commitment is to meet the changing needs of healthcare systems and to lead the industry by providing quality surgical instruments and dental instruments at competitive price.

We understand the diverse needs of our customers and know that quality along with delivery time are the most important and common requirements of our customers from both segments. This Realization allows us to serve our customers in the most efficient and cost effective manners.

Wish you all the Best.

PHOENIX SURGICAL

01	Locking and plates	Page 01 to 05
02	Intramedullary Nails	Page 06 to 10
03	Screws and Staple	Page 11
04	Spinal Fixation	Page 12 to 15
05	Joint Replacements	Page 16 to 18
06	Sports Medicine	Page 19 to 21
07	CMF System	Page 22
08	External Fixator	Page 23

01

EN Locking and Plates

Page 01 to 05





Volga
PE-3001

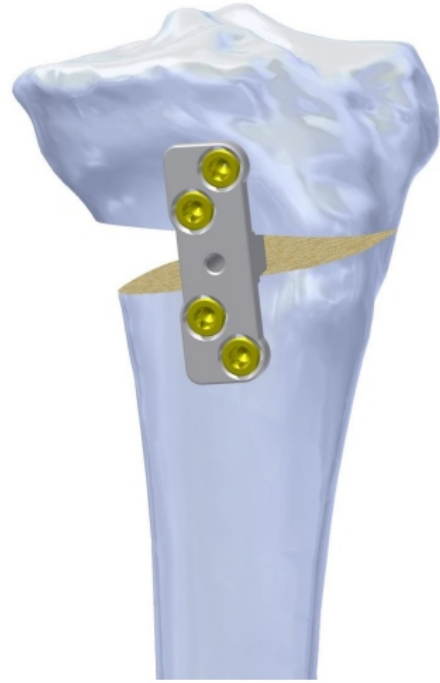

Pudu-x
PE-3002



Eight-q
PE-3003



Volga
PE-3004



Amazon
PE-3005



Donav
PE-3006



Oviedo
PE-3007

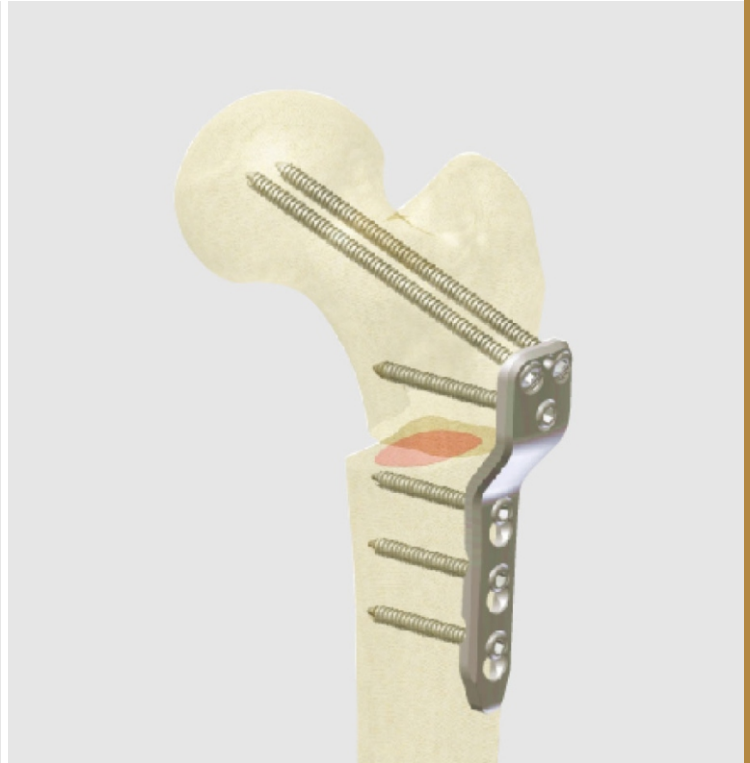

Astron
PE-3008

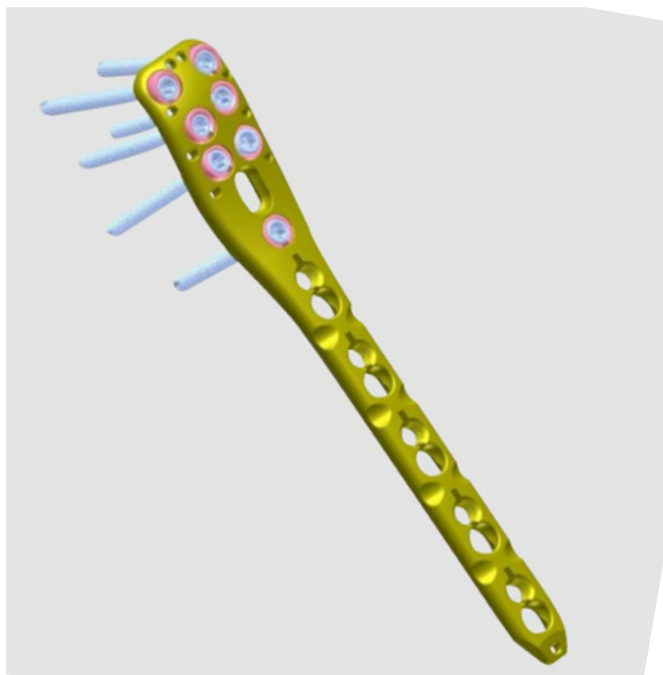

Thames
PE-3009

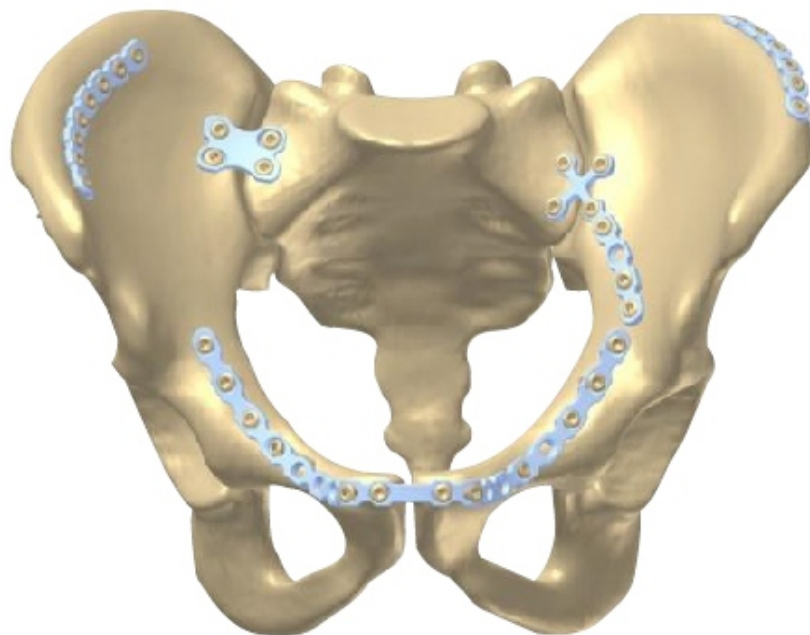

Mantaro
PE-3010

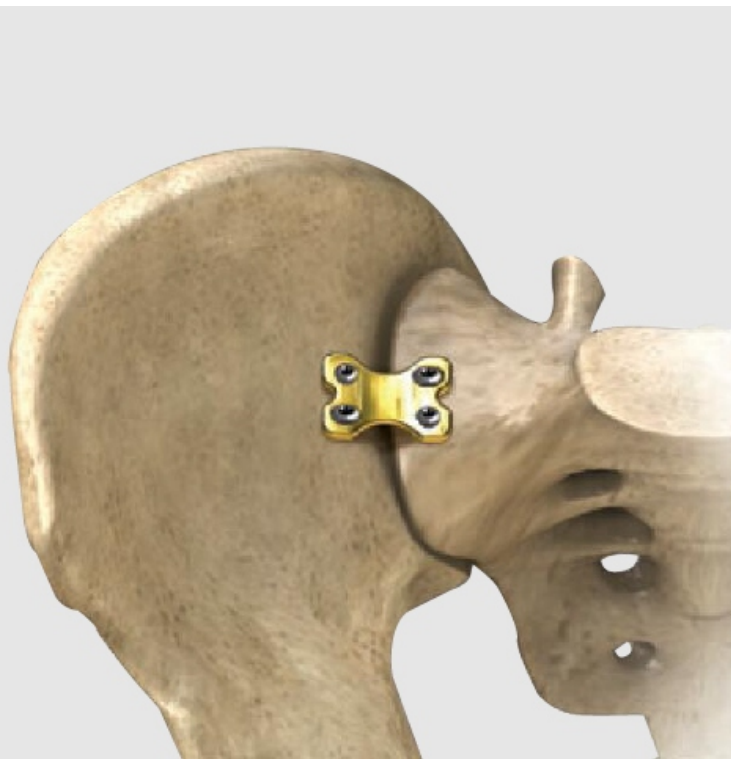

Kepler
PE-3011



Auxo
PE-3012



Dcs and Dhs Plates
PE-3013



Dcp Plates
PE-3014



Amazon VA
PE-3015

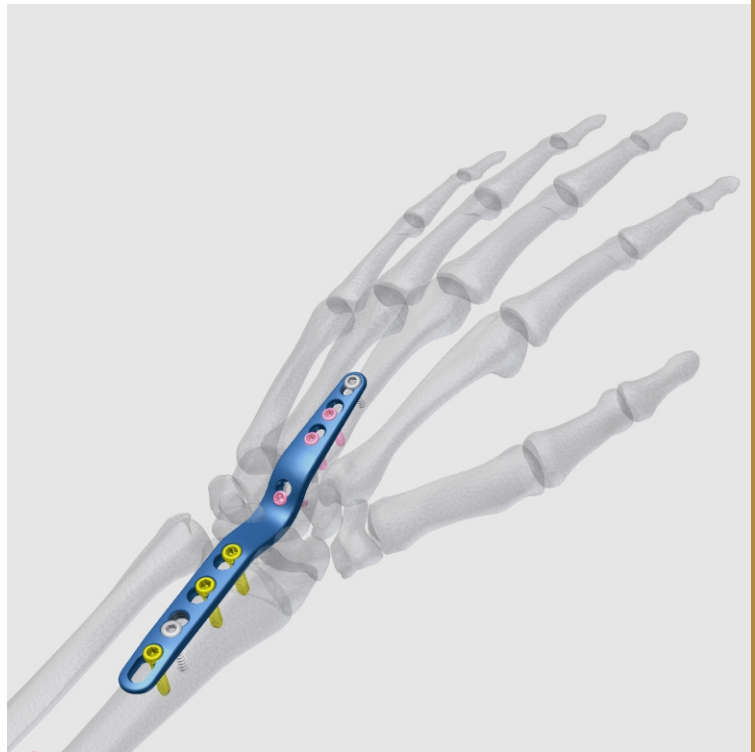

LCP
PE-3016

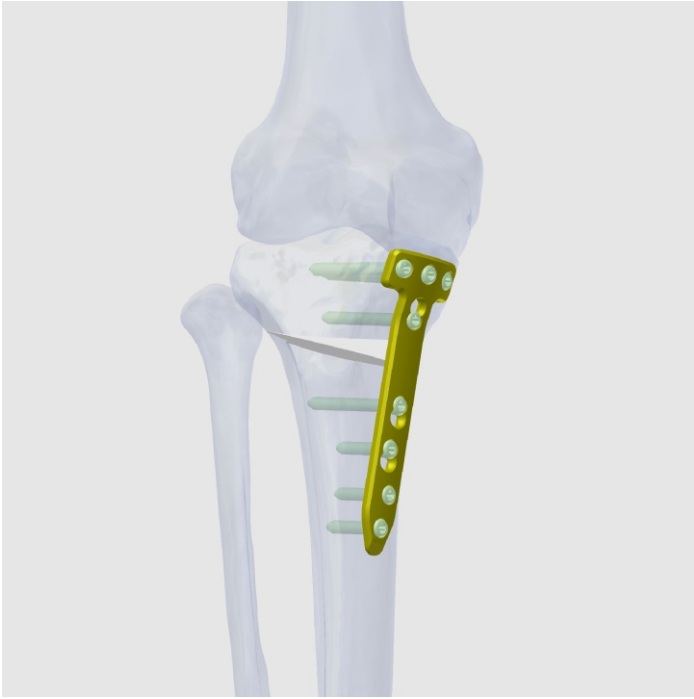

Lena Lcp Peri
PE-3017

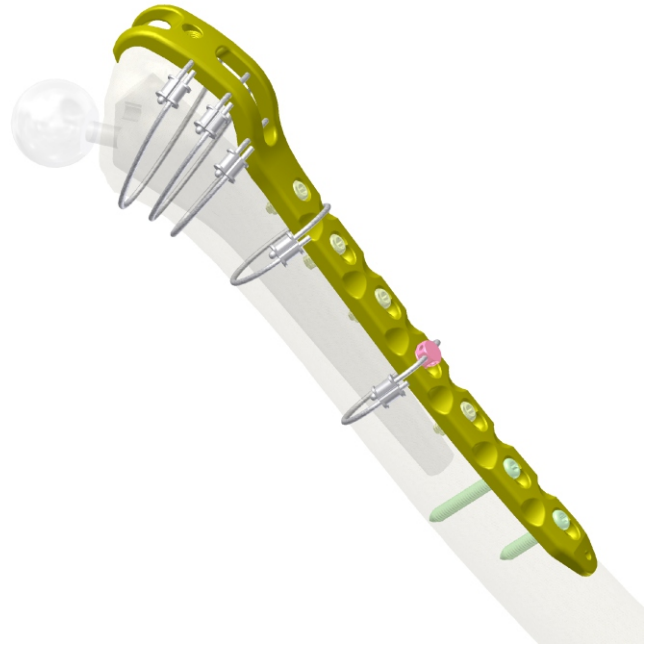

Marvel
PE-3018



Tiber
PE-3019

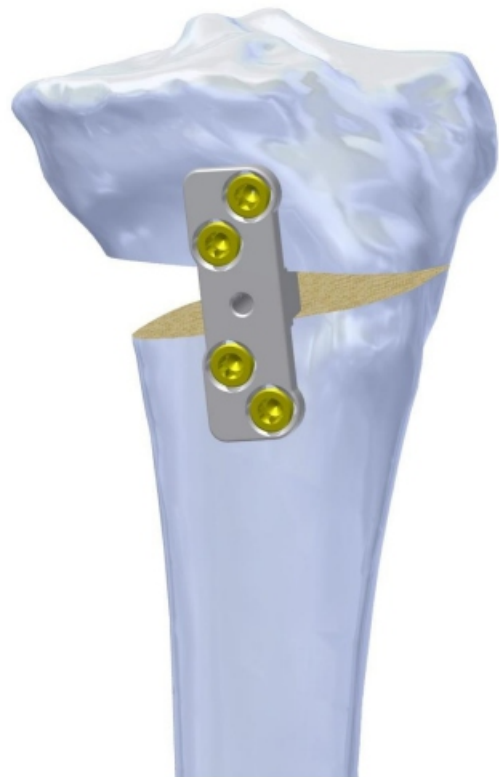

Pudu-x
PE-3020

02

EN Intramedullary Nails

Page 06 to 10

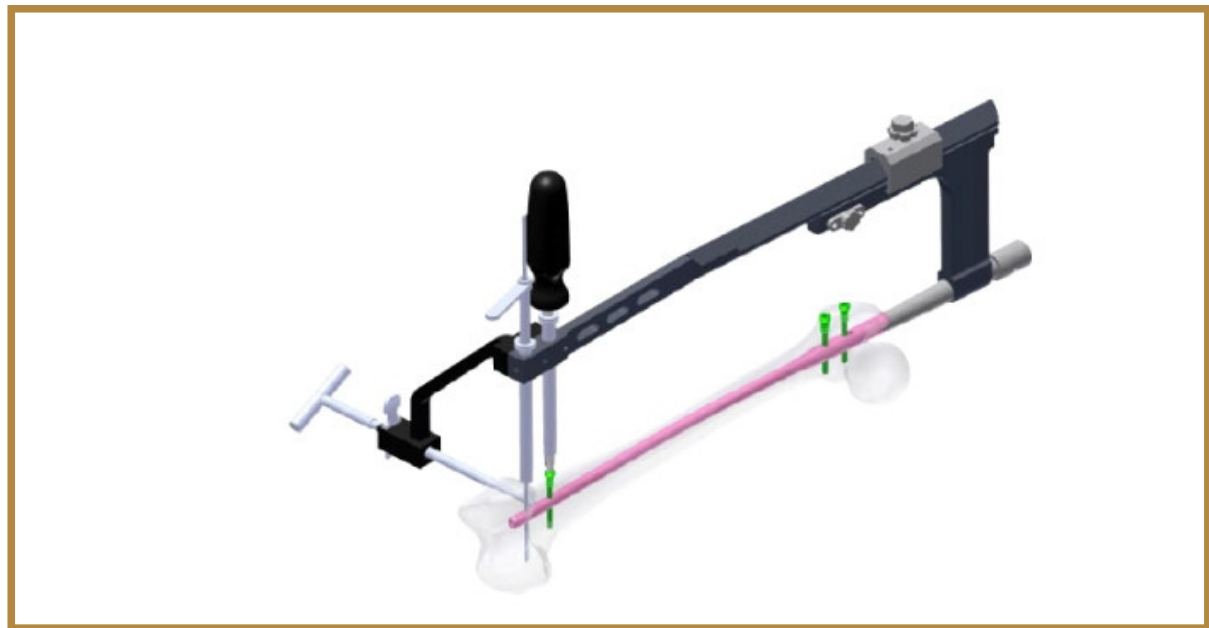



Bison
PE-3101

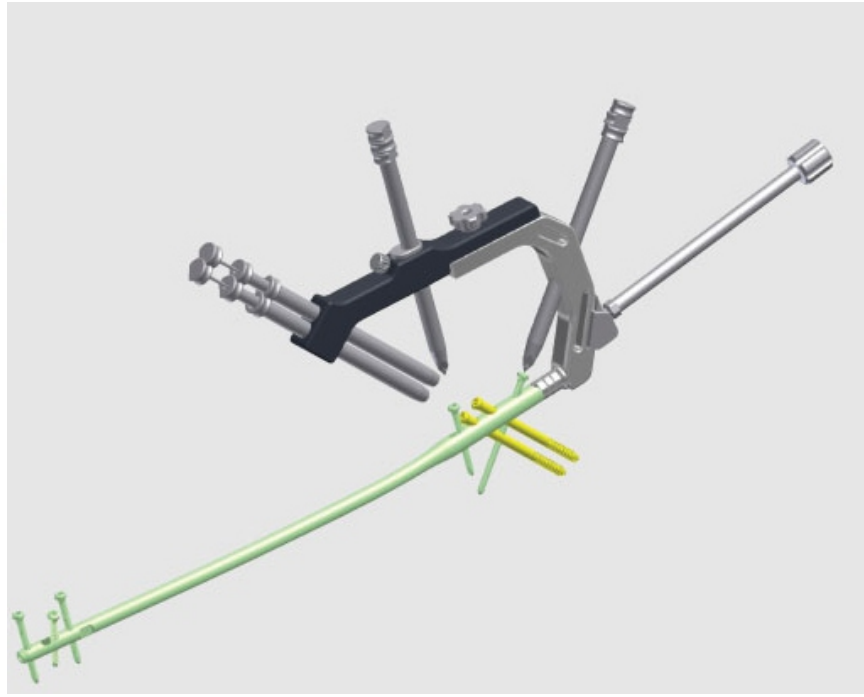

Makalu
PE-3102



Atlas
PE-3103



Seine
PE-3104



Alps
PE-3105



Andes
PE-3106



Himalaya
PE-3107

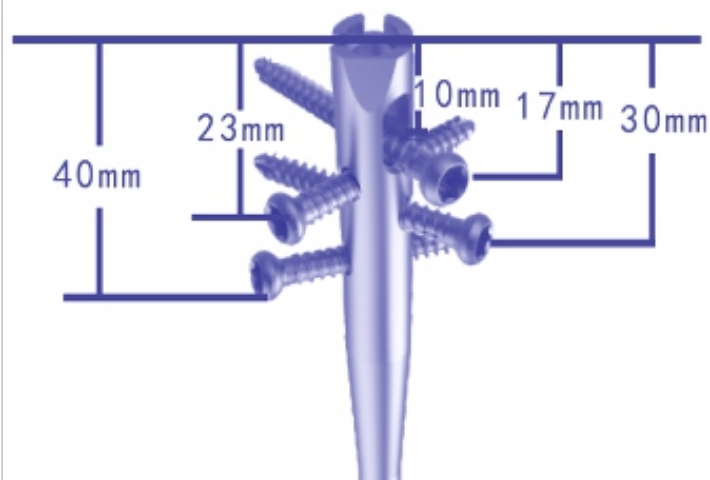

Elbrus
PE-3108



Rocky
PE-3109



Divide
PE-3110



K-2
PE-3111



Colorado
PE-3112



McKinley
PE-3113



Merope
PE-3114



Lhotse
PE-3115



Athos
PE-3116



Elora
PE-3117



Manasa
PE-3118



Ajanta
PE-3119

03

EN Screws and Staple

Page 11

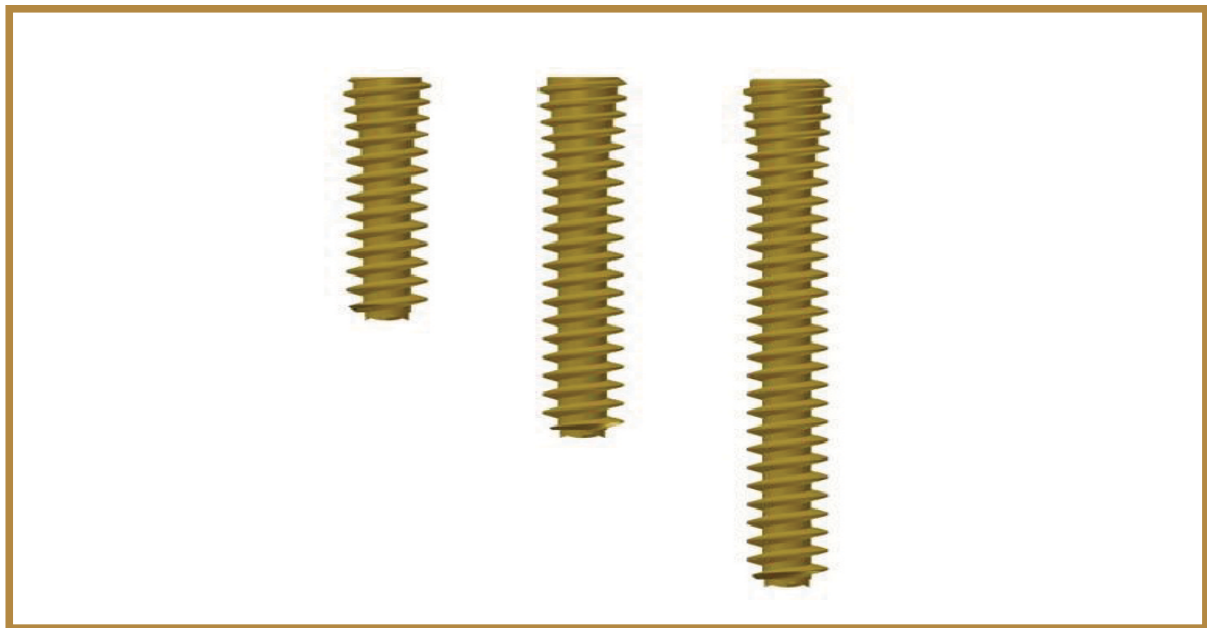



Uranus
PE-3201

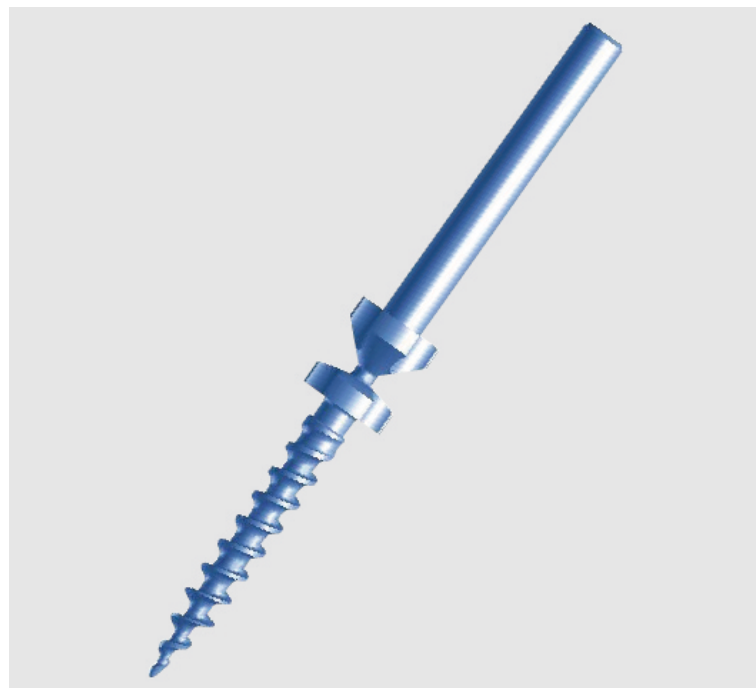

Tulip
PE-3202

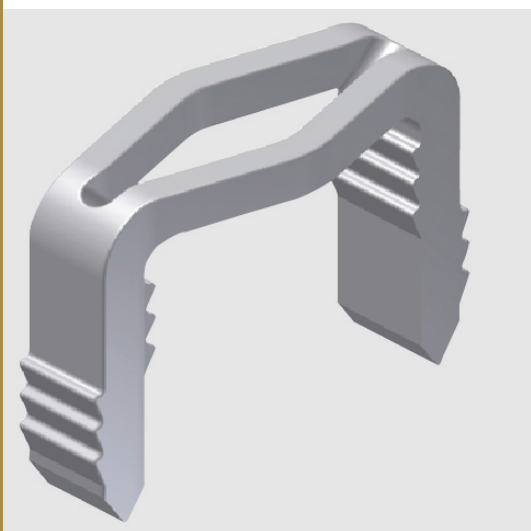

Dahlia
PE-3203

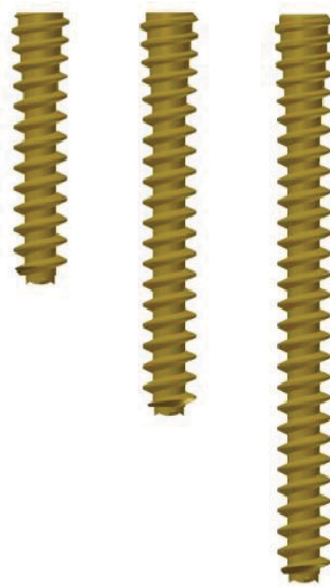

Protea
PE-3204

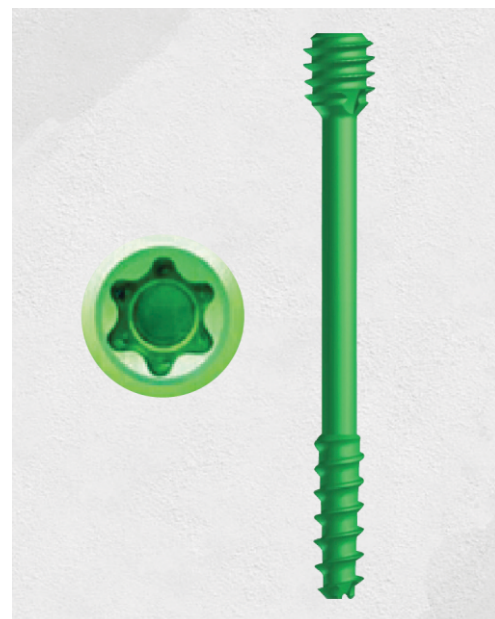

Ghats
PE-3105

04

EN Spinal Fixation

Page 12 to 15

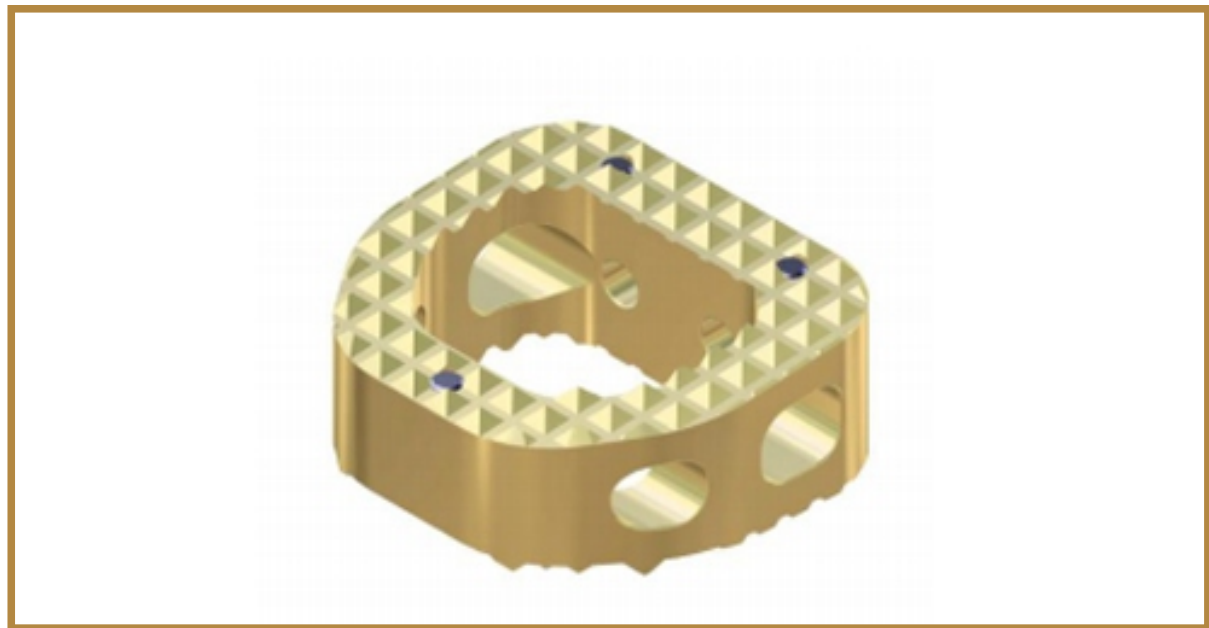

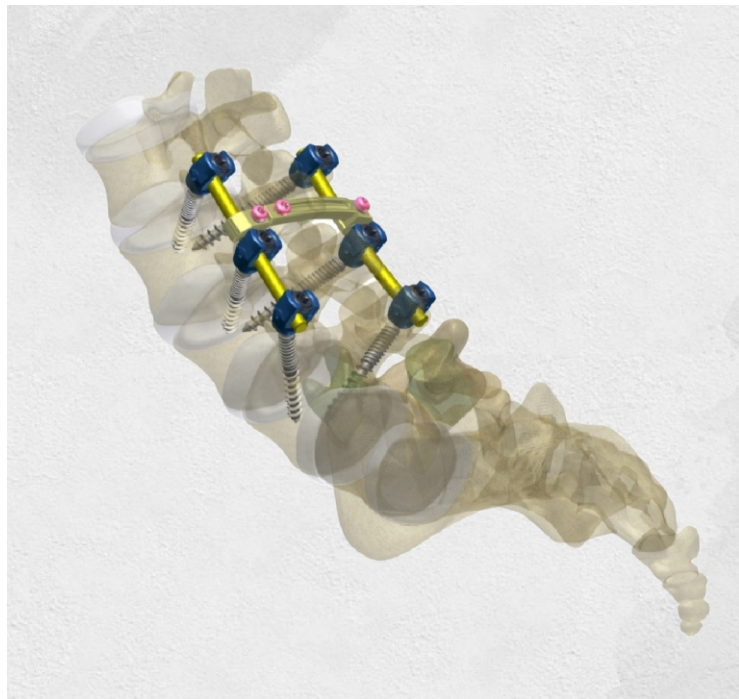

Neptune 5.5 Degenerative
PE-3301

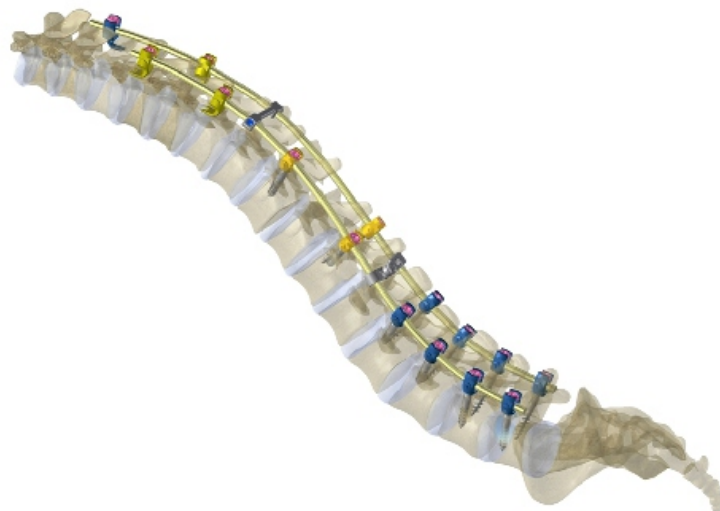

Neptune 5.5 Deformity
PE-3302

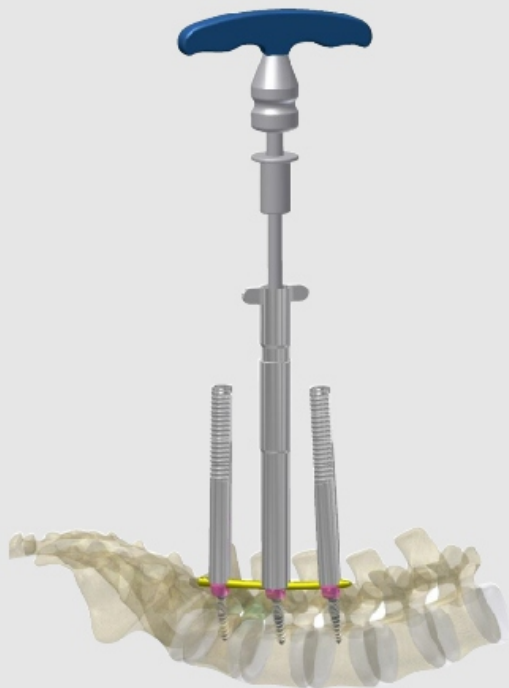

Neptune 5.5 Mis
PE-3303

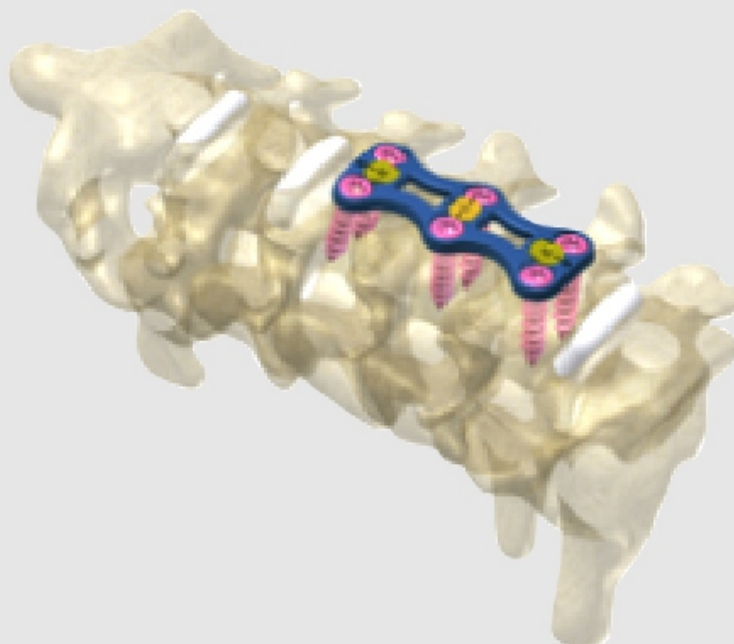

Venus
PE-3304

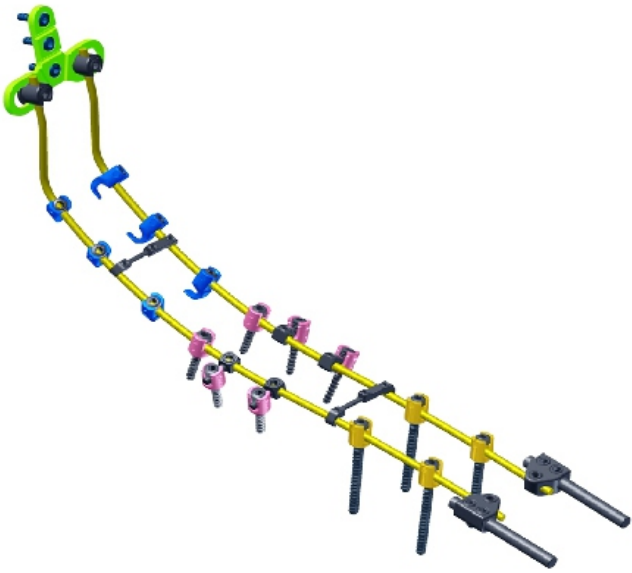

Pluto
PE-3305

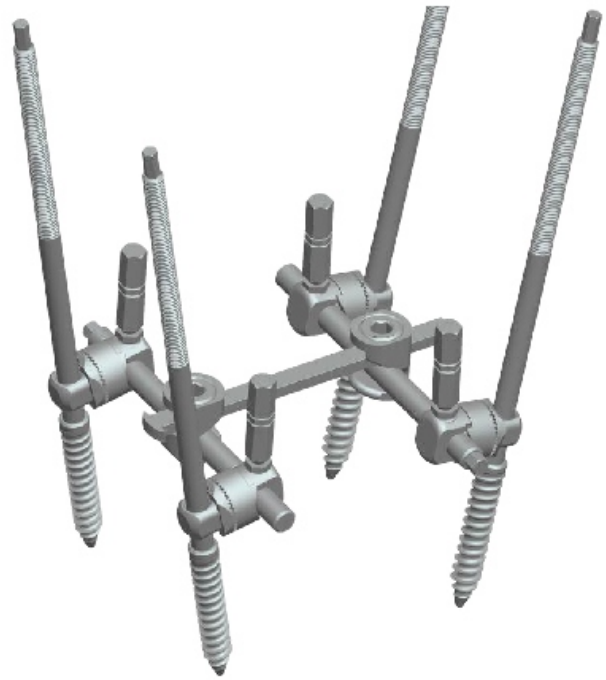

Saturn
PE-3306



Neptune Miras
PE-3307

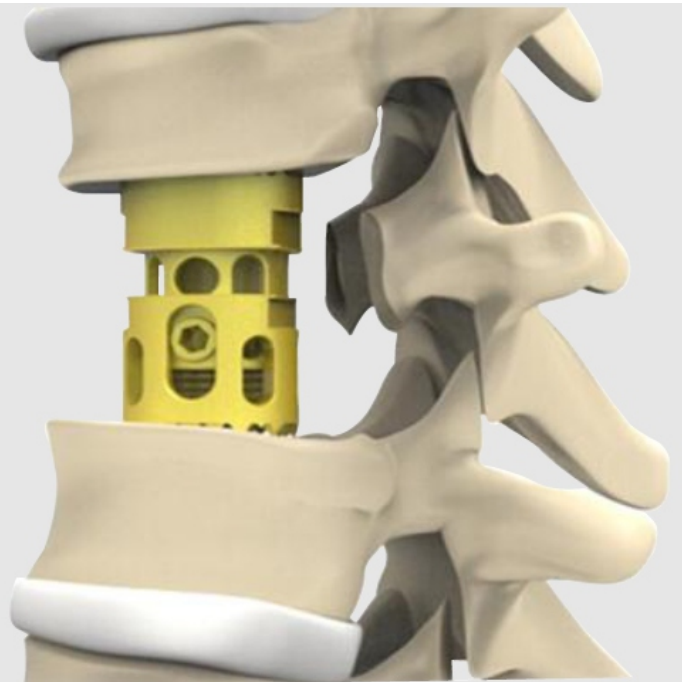

Prima Vbr
PE-3308



Tslp Plate
PE-3309

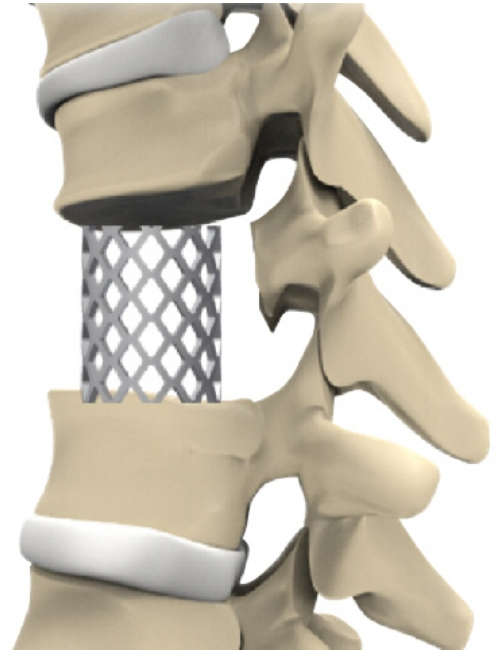

Earth
PE-3310

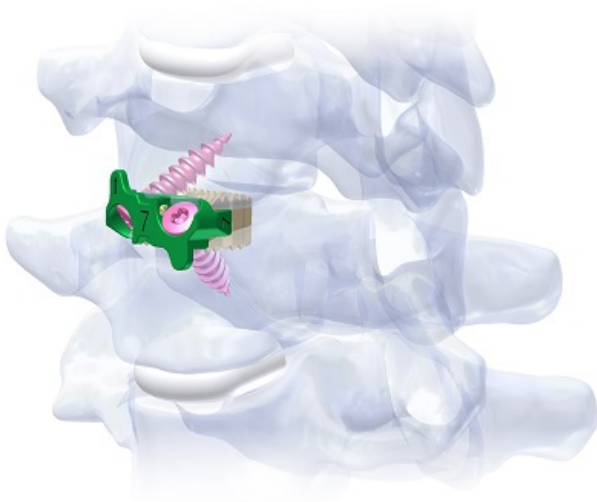

Minerva
PE-3311

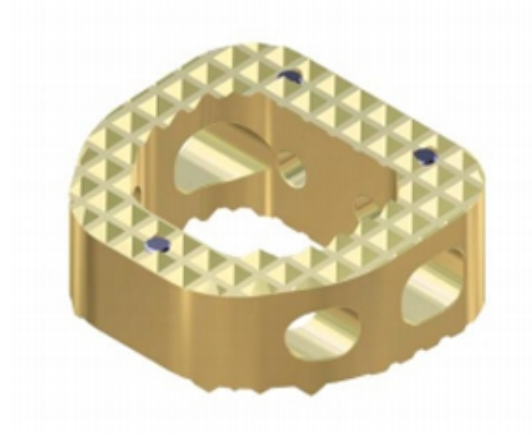

Mars
PE-3312

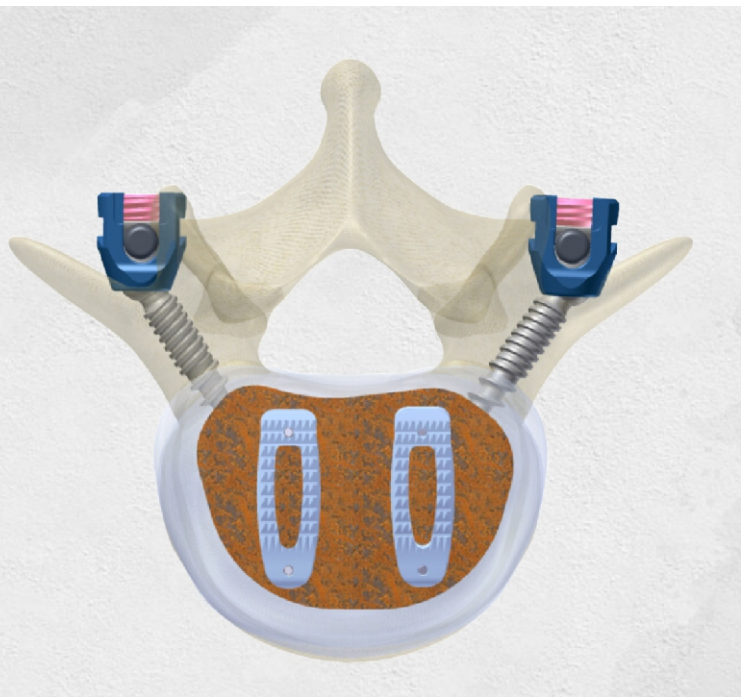

Jupiter
PE-3313

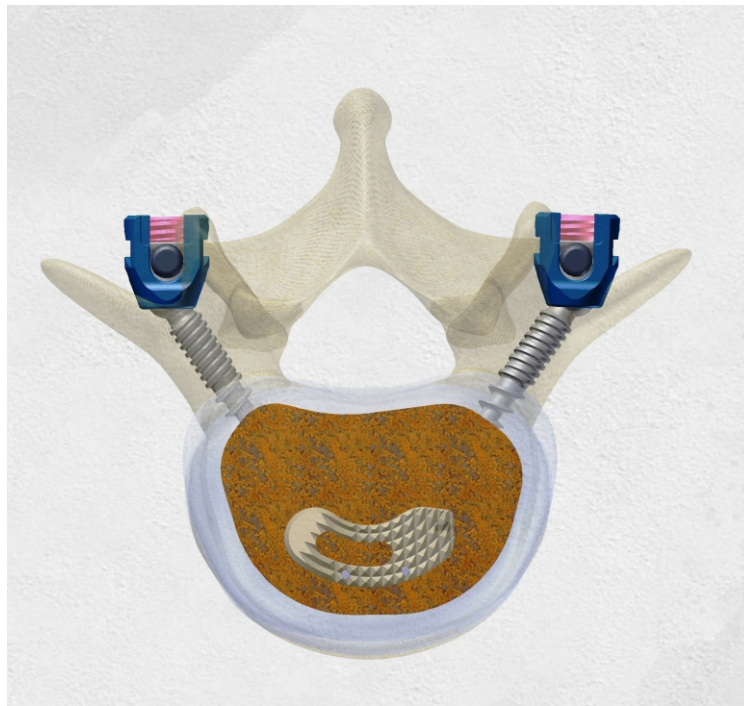

Mercury
PE-3314

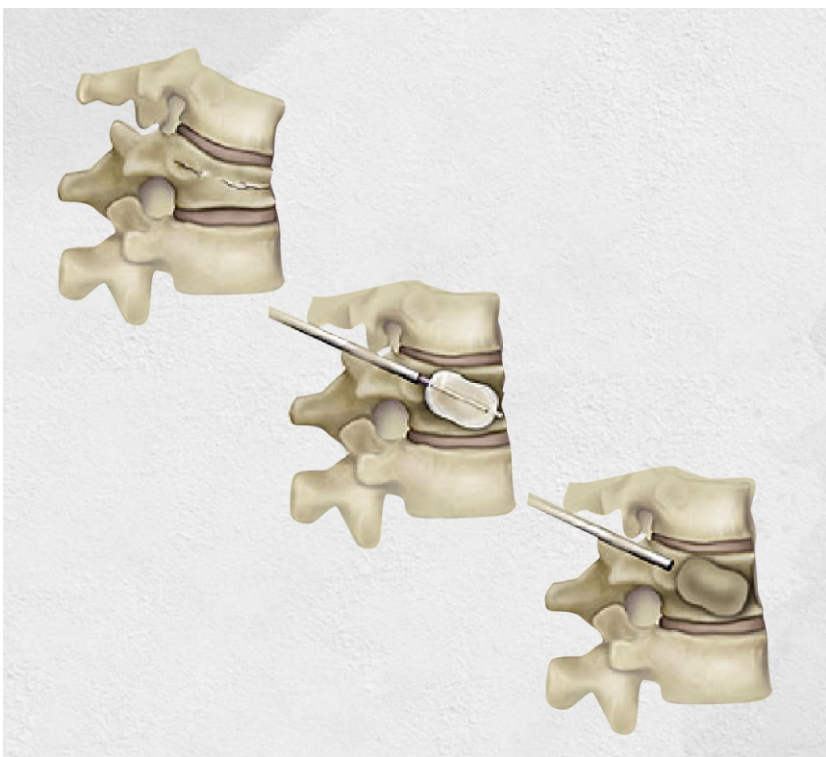

Kyphoplasty
PE-3315



Interspinous Device
PE-3316

05

EN Joint Replacements

Page 16 to 18

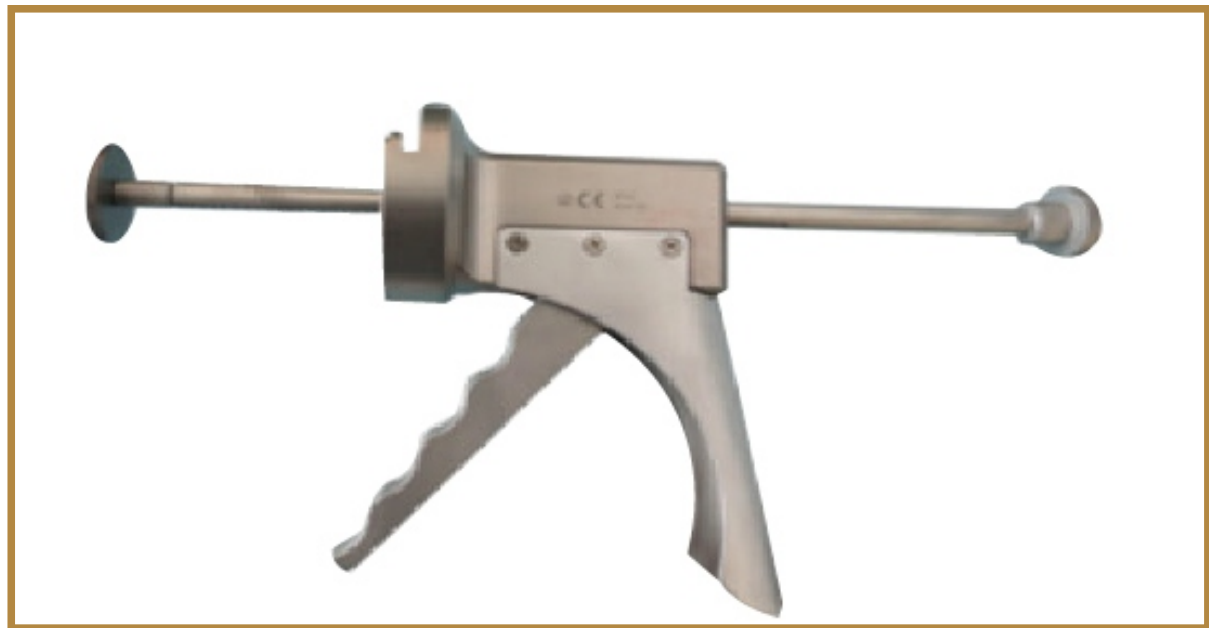



Primary Knee System
PE-3401



Revision Knee System
PE-3402



Non-cemented Stems
PE-3403



Cemented Stems
PE-3404



Acetabular Cups
PE-3405

Femoral Head
PE-3406



Madison Ortho
PE-3407



Surgical Lavage
PE-3408

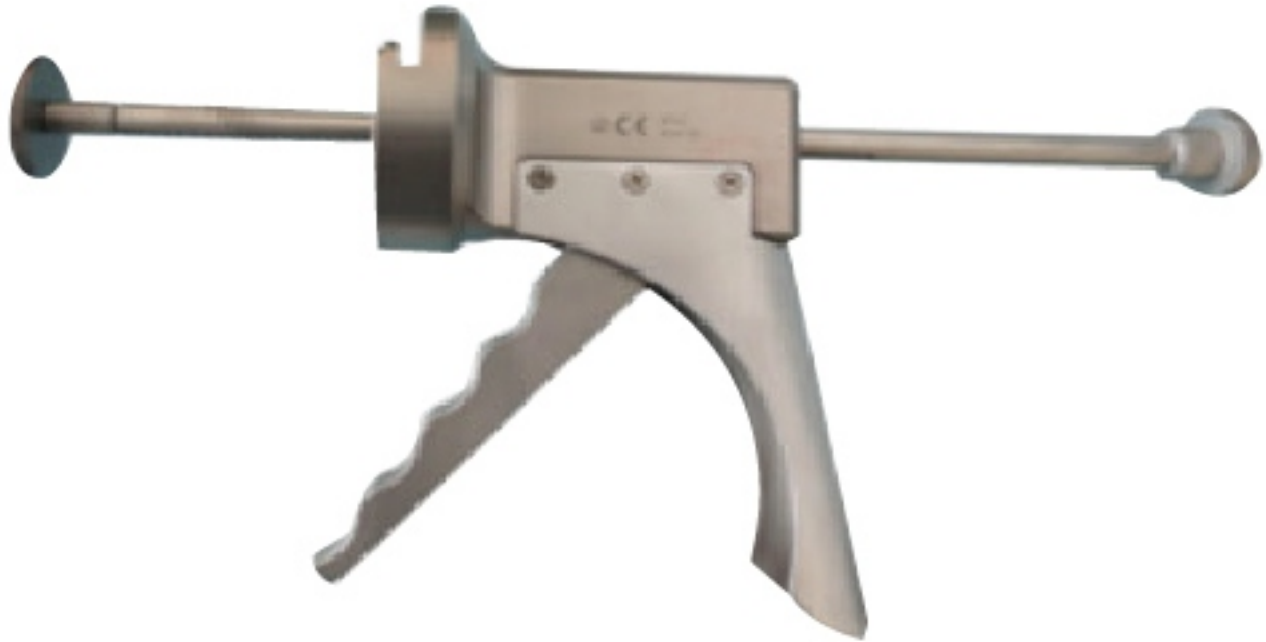

Bone Cement Application
PE-3405

06

EN Sports Medicine

Page 19 to 21

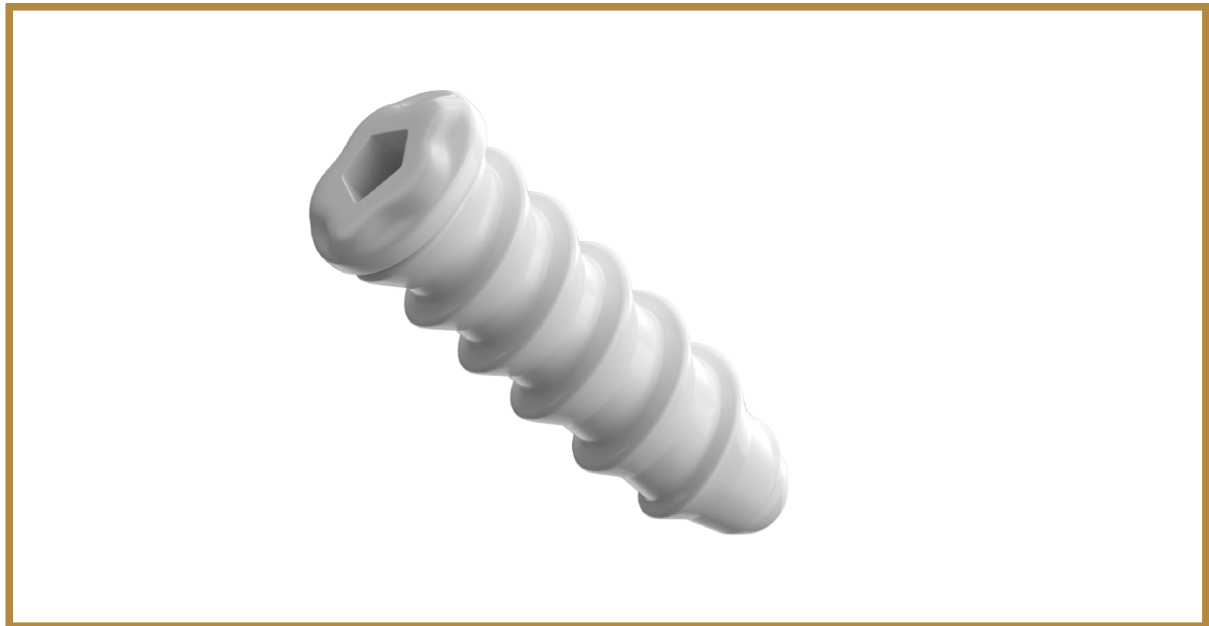



Infiloop
PE-3501



Proloop
PE-3502



A Helysis
PE-3503



B Helysis
PE-3504



C Helysis
PE-3505

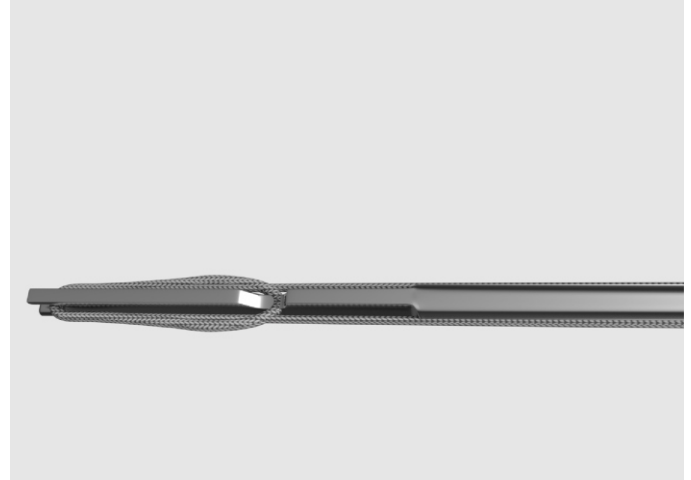

A Stativ
PE-3506



Titanium
PE-3507

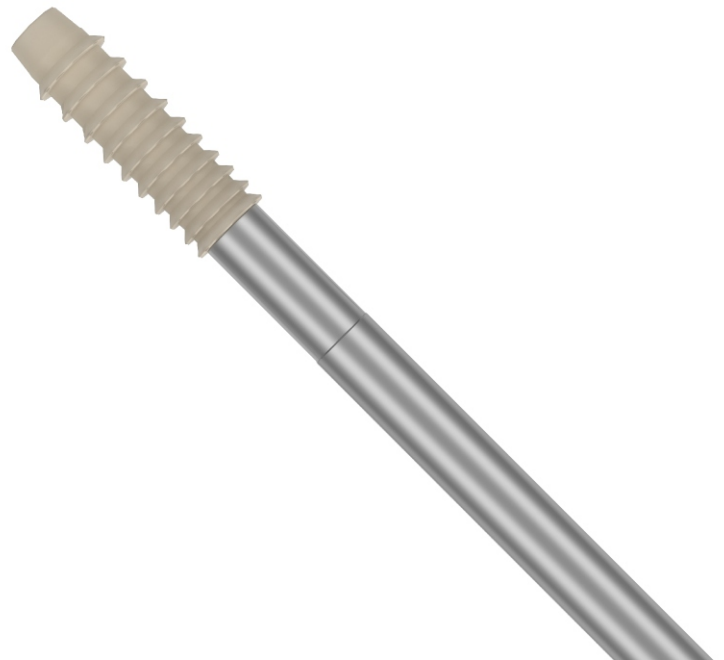

B Spyke
PE-3508



A Stativ
PE-3509



Cepter Cuff
PE-3510



Cepter Cuff
PE-3511



Viplok
PE-3512

07

EN CMF System

Page 22

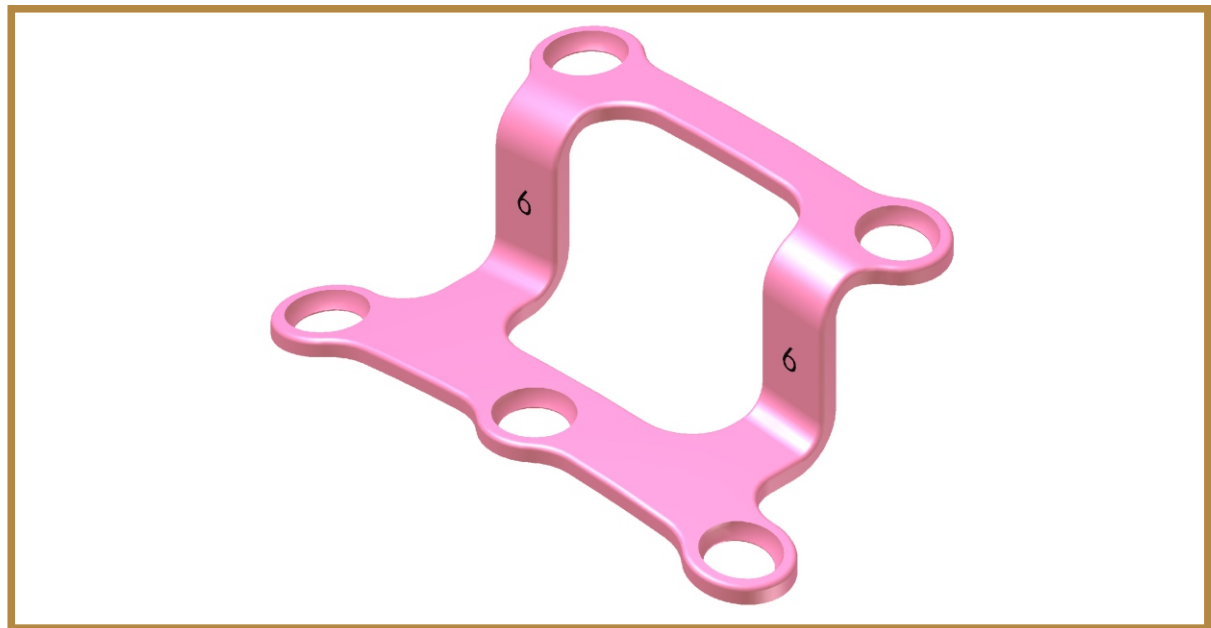

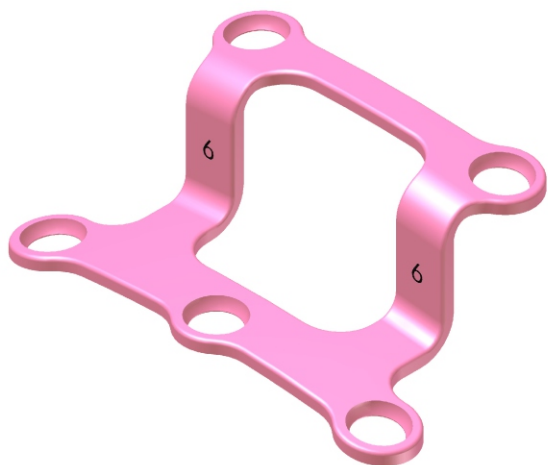

Chin Plates
PE-3601

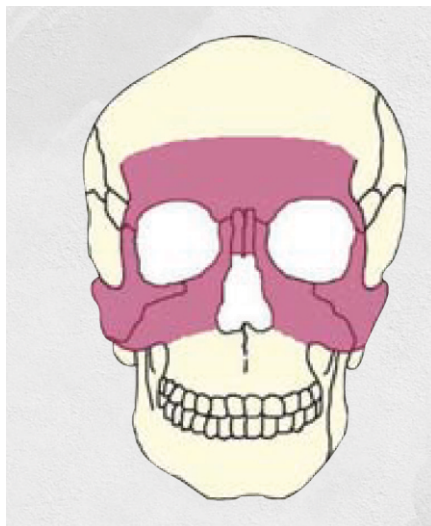

Rhein
PE-3602

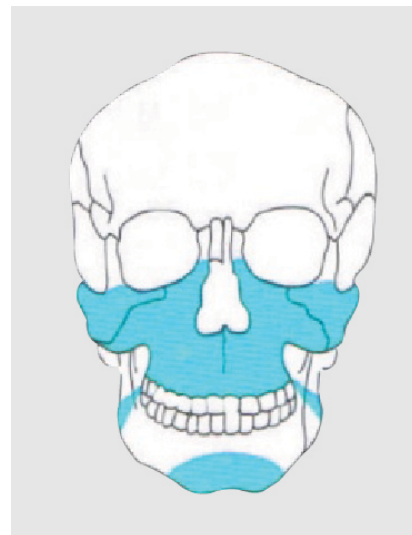

Rhein 2.0
PE-3603

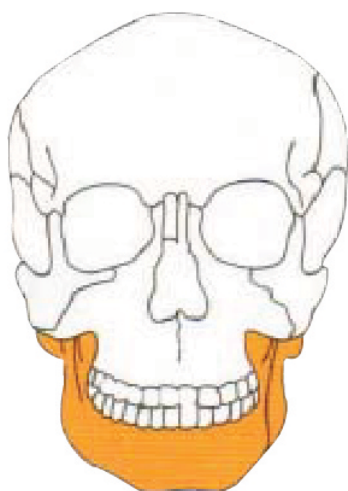

Rhein 2.4
PE-3604

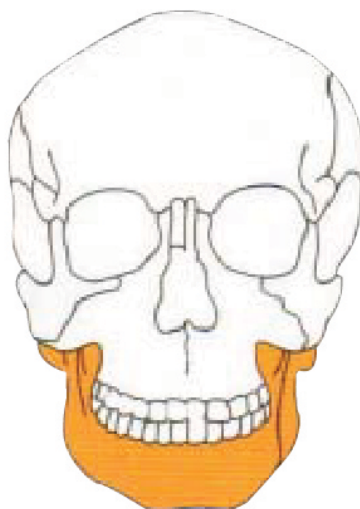

Rhein 2.0 Lock
PE-3605

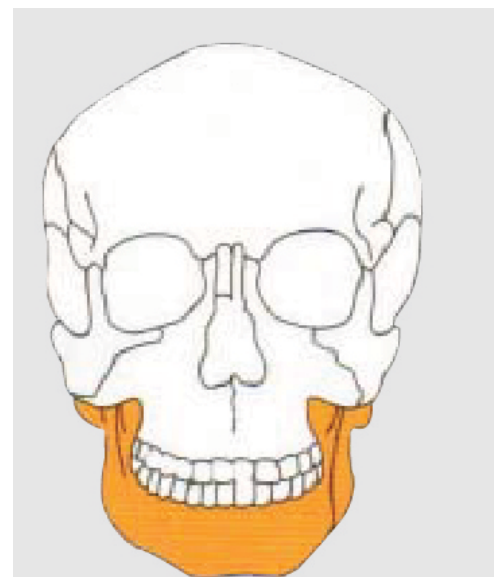

Rhein 2.4 Lock
PE-3606

08

EN External Fixator

Page 23





Chin Plates
PE-3601

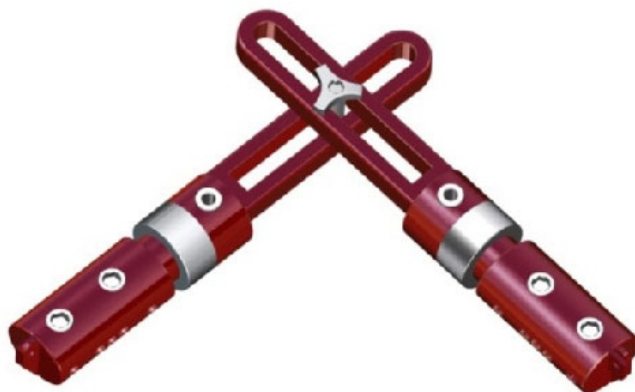

Rhein
PE-3602

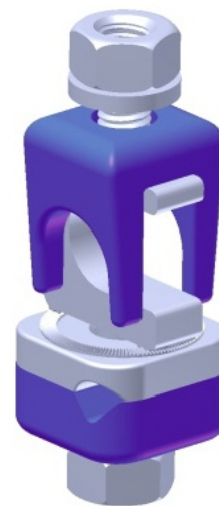

Rhein 2.0
PE-3603



Rhein 2.4
PE-3604

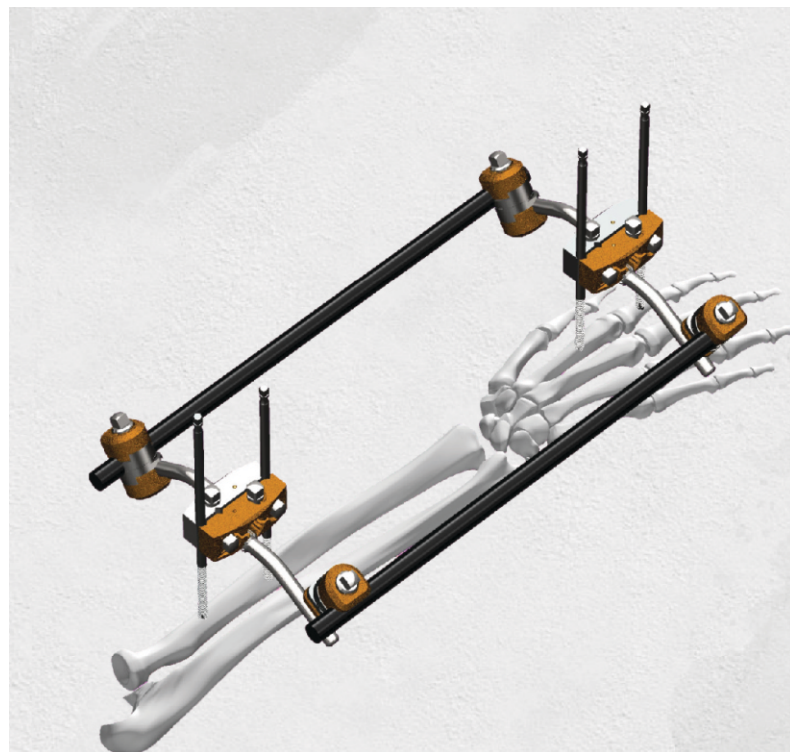

Rhein 2.0 Lock
PE-3605



69-A Trust Plaza G.T Road
Gujranwala. 52250, Pakistan

Tel/ Whats app: +92 344 1402620

Email: info@phoenixsurgicalsolution.com
sales@alshariftradingco.com

Web: phoenixsurgicalsolution.com